



# Air conditioning and chillers

Customized heat transfer solutions



# Heat transfer solutions that will help you break barriers

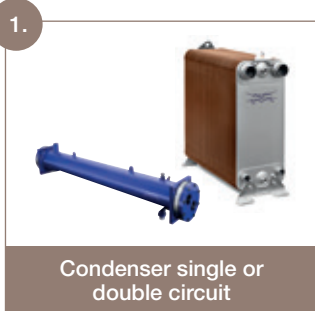
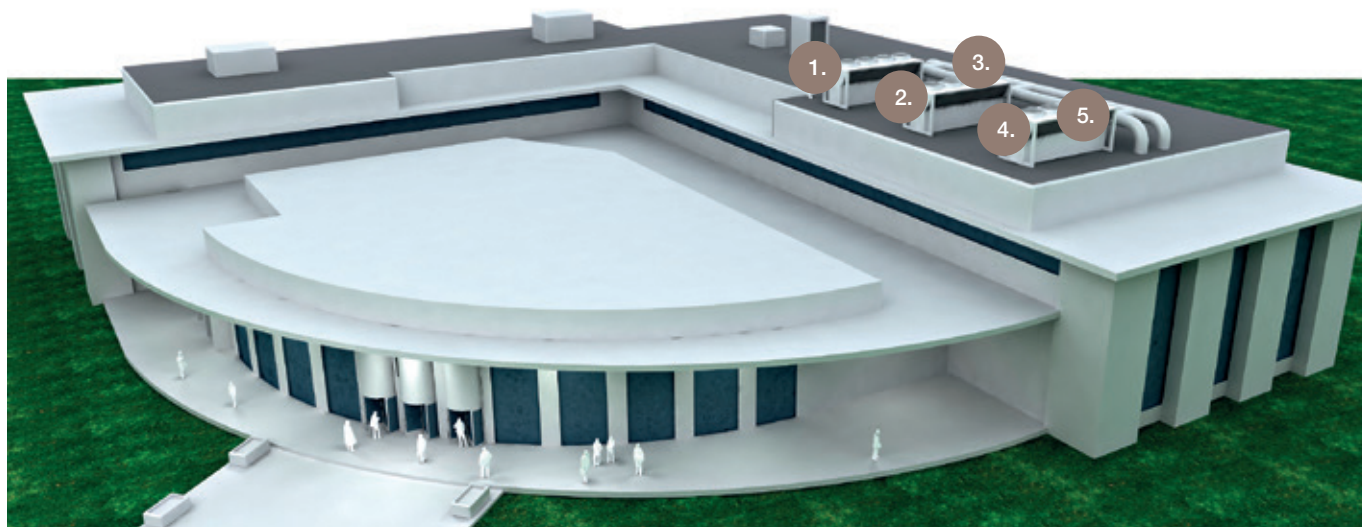

Heat exchangers can serve many different purposes in a chiller. These are the most common:

- *Evaporator* – providing the cooling effect between the refrigerant and the water/brine.
- *Condenser* – enabling the condensation of the refrigerant by rejecting heat to another media. In an air-cooled chiller this media is air; in a water-cooled chiller it is a liquid.
- *Economizer* – increasing the enthalpy effect by boosting sub-cooling in the condensed refrigerant. This increases overall system efficiency.
- *Desuperheater* – recovering the heat from the super-heated refrigerant gas at the compressor outlet.
- *Compressor oil cooler* – Screw or centrifugal compressors may require cooling to increase lifetime and/or efficiency. It can be a refrigerant-to-oil or water-to-oil heat exchanger.

## Basics about air conditioning and chillers

The purpose of a chiller is to produce cold water or brine, which is transferred to the ambient or to a process – either directly or through a distribution unit. Cooling is normally achieved through a compressor-driven refrigeration cycle. Chiller systems use various types of refrigerants and compressors – the following being the most common:

- *Scroll compressors*: small to medium-sized chillers (can also be configured in multiple-scroll series)
- *Screw compressors*: medium-sized to large chillers
- *Centrifugal compressors*: large to very large chillers
- Absorption chillers are compressor-free

In addition to the type and size of compressor, chillers can also be categorized according to the heat-rejection method. *Air-cooled chillers* use air coils as the condenser, from which the heat is vented to the ambient. For this reason, air-cooled chillers have a larger footprint than water-cooled chillers of similar specifications. *Water-cooled chillers* reject the heat from the condenser into a water circuit. Here, the heat can be recovered and used for heating purposes. It can also be released to the ambient, using for example cooling towers or liquid coolers.

# The Alfa Laval adv

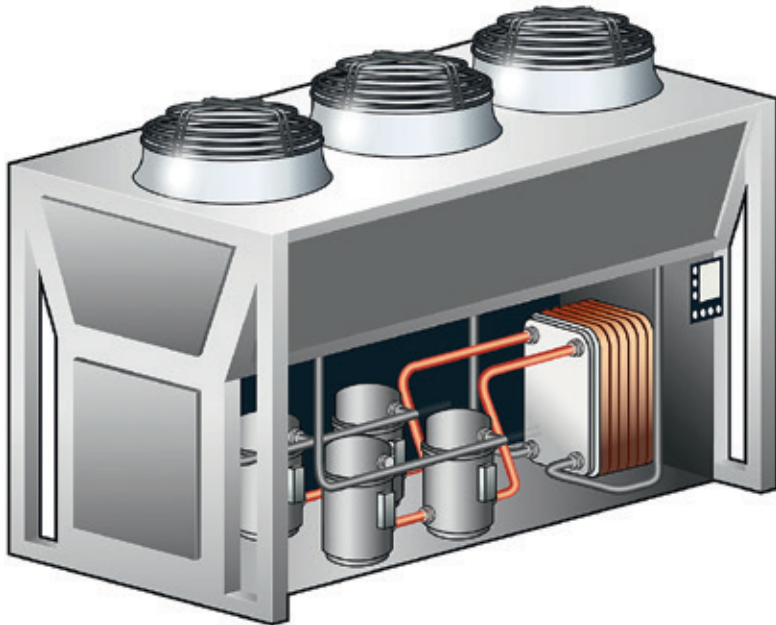

Alfa Laval offers a complete range of heat exchangers – brazed heat exchangers (BHE), shell-and-tube heat exchangers (S&T) and air heat exchangers (AHE). BHEs are very compact compared to any other heat exchanger for similar applications. This means less refrigerant is needed.

All BHE units are pressure-tested and labelled to comply with all major industry approvals (PED, UL, Chinese PV, KHK, KRA, and CRN). They are also leak-tested with helium to ensure that every unit is gas tight. All

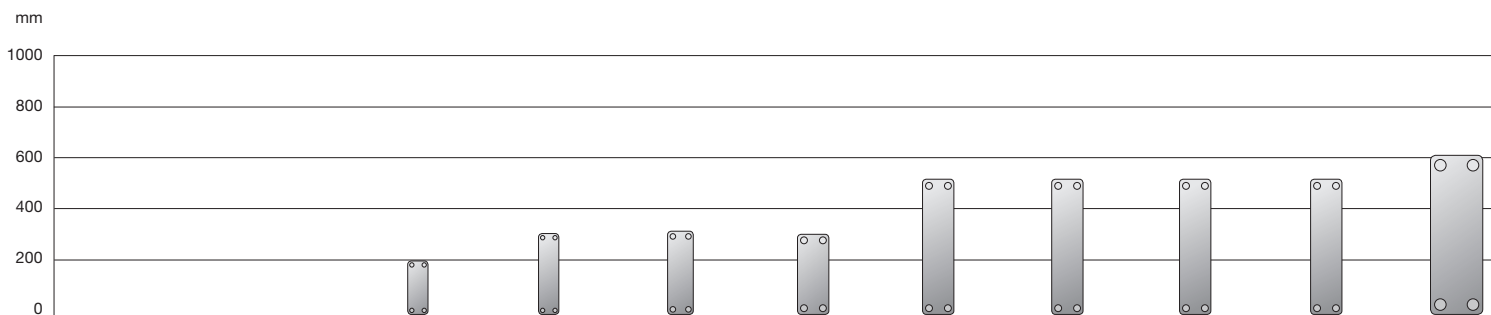

## Air Conditioning

	AC16	AC18	AC30	CB30	AC70	AC72	AC73	CB60	AC112
Evaporator	x	x	x		x	x	x	x	x
Condenser	x	x	x	x	x	x	x	x	x
Economizer	x	x	x		x			x	
Oil cooler		x		x				x	
Desuperheater		x		x				x	
Dimensions	see product leaflet								
Design Pressure	32/45	32/45	32/45	32/45	32/45	32/48	32/48	32/45	32/48
Distribution System**			x	(x)	x	x		(x)	(x)
DynaStatic Distribution							x		
Assymetric plates available	x	x				x	x		x
High Theta plates available	x	x	x	x	x	x	x	x	x
Low Theta plates available				x	x			x	x
Combination High & Low				x	x			x	x
High Efficiency						x	x		x

\*\* (x) = optional

# Advantage

relevant approvals are also available for air heat exchangers and shell-and-tube heat exchangers.

For OEM customers, Alfa Laval can optimize the BHE according to specific applications and system requirements. Each optimized heat exchanger is unique to the customer, with a unique article number. Customers can be safe in the knowledge that Alfa Laval uses all its know-how to optimize their products.

Continuous innovation and product development are ensured by Alfa

Laval's in-house laboratory. All developments and solutions are validated before being offered to customers.

## Product scope

### EVAPORATORS

The main focus of Alfa Laval's heat exchangers in chillers is on the evaporator. This function is critical to the performance of the entire chiller. Alfa Laval offers BHEs with different distribution systems and channel plates to optimize the performance of the unit for the customer's application and

operating conditions. Alfa Laval also offers S&T evaporators. The in-depth knowledge of both technologies allows Alfa Laval to find the optimal solution for each customer.

### CONDENSERS

All BHE evaporators can operate in reversible mode – in other words as condensers. Optimized condensers are available for water-cooled chillers. To minimize the footprint, the condenser has the same aspect ratio as the evaporator. Performance is further optimized by using different corrugation angles, pressing depths and asymmetric plate channels. Alfa Laval also offers a full range of S&T condensers, for applications or environments where water quality is poor or uncertain.

### ECONOMIZERS/SUBCOOLERS

For large screw or centrifugal chillers, Alfa Laval offers BHE units designed as evaporators, with the option of other material specifications and with or without a distribution system, depending on pressure-drop requirements.

### DESUPERHEATER

Alfa Laval offers BHE units with very low pressure drops to control the refrigerant circuit and avoid negative effects on the condensing pressure. Generally, these units are designed with large ports and smaller theta angles. Shell-and-tube heat exchangers are also a valid alternative for this purpose. They are able to handle larger volumes and allow heat to be recovered on the condensing side.

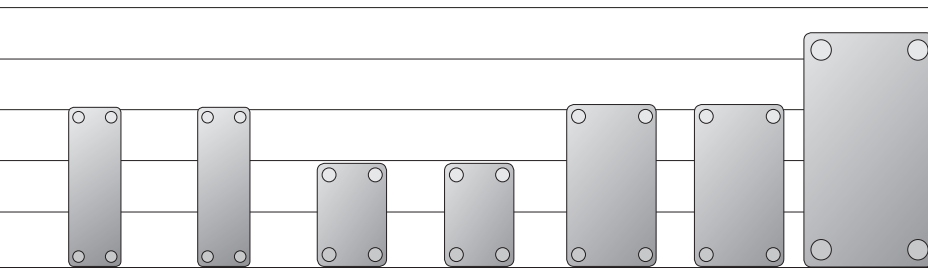

	CB110	AC220	AC230	AC232	AC500	AC502	AC1000
		x	x	x	x	x	x
	x	x	x	x	x	x	x
		x			x	x	
	x						
	x						
see product leaflet							
	32/48	32/45	32/45	32/45	32/45	32/45	48
		x	x	x	x	x	x
		x				x	x
	x	x	x	x	x	x	x
	x	x					
	x	x					
		x		x		x	x

# Three innovations that break barriers

## OIL COOLERS

Large chillers may require oil coolers for the compressors. BHEs provide an efficient solution, with the added benefit of compactness and a reduced pressure drop. Low pressure drops on the oil side is a key factor in this application, and Alfa Laval's range of low-theta plates is therefore a good solution.

## SHELL & TUBE HEAT EXCHANGER AND AIR HEAT EXCHANGER RANGE

In order to provide our customers with a full range of products, Alfa Laval also develops and promotes shell&tube and air heat exchangers. Tubular heat exchangers for air and process conditioning duties, with patented distribution system and dedicated design for respectively positive or negative temperatures. We cover all dry expansion duties up to 2000kW. Air cooled condensers for condenserless chillers and Liquid Coolers for water cooled chillers, designed for different refrigerants and a variety of ambient conditions.

## AC1000 XTRM / CAPACITY

The largest borehole heat exchanger on the market features a flexible design and delivers major energy savings. With these highly efficient plates, you can either expand capacity or reduce the total number of plates in your system.

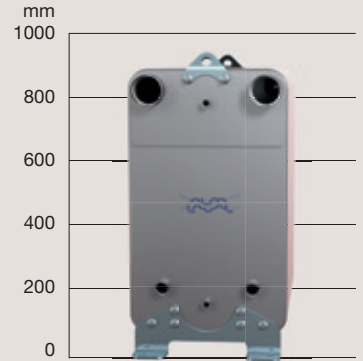

## DYNASTATIC DESIGN / FLEXIBILITY

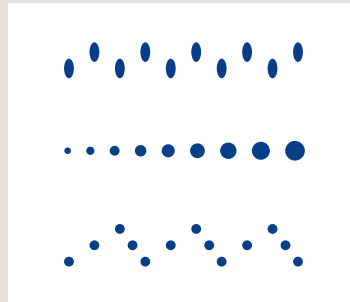

This breakthrough production method gives you complete freedom to design the perfect refrigerant distribution system for your products. Whatever placement, size and number of distributors you want, we can produce it.

## FLEXFLOW DESIGN / EFFICIENCY

Our range of asymmetrical flow patterns unlock new levels of efficiency. We don't believe in a one size fits all approach – we develop new asymmetrical patterns tailored by application.

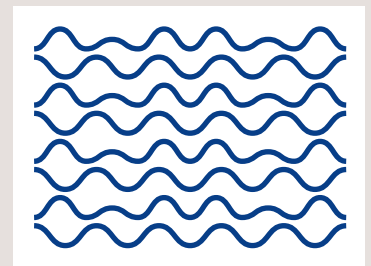



## Partner with Alfa Laval to become best in class

With our unique wealth of experience, our dedication to finding innovative new heat transfer OEM solutions with greater efficiency and lower energy consumption and our global manufacturing and distribution network, Alfa Laval is your ideal partner.

Don't get left behind in a competitive market, affected by a constant flow of new regulations and ever-changing trends. We support your need to drive performance to new levels as well as the need of cost-efficient solutions.

Join forces with Alfa Laval and be the best that you possibly can.

### OEM applications

- Air Conditioning (Chillers, Absorption Chillers and VRF's)
- Heat Pumps
- Boilers
- Solar Heating
- Domestic Water Heating
- Process Cooling
- Fuel Cells
- (Micro) Combined Heating and Power
- Air Dryers
- Air Compressors
- Oil Cooling
- Transport Refrigeration
- Wind Power
- Vending Machines

#### How to contact Alfa Laval

Up-to-date Alfa Laval contact details for all countries are always available on our website at [www.alfalaval.com](http://www.alfalaval.com)